

SAMÞYKKT AF BYGGINGARFULLTRÚA
28. APR. 2021
BYGGINGARFULLTRÚNNI VESTMANNÆYJUM

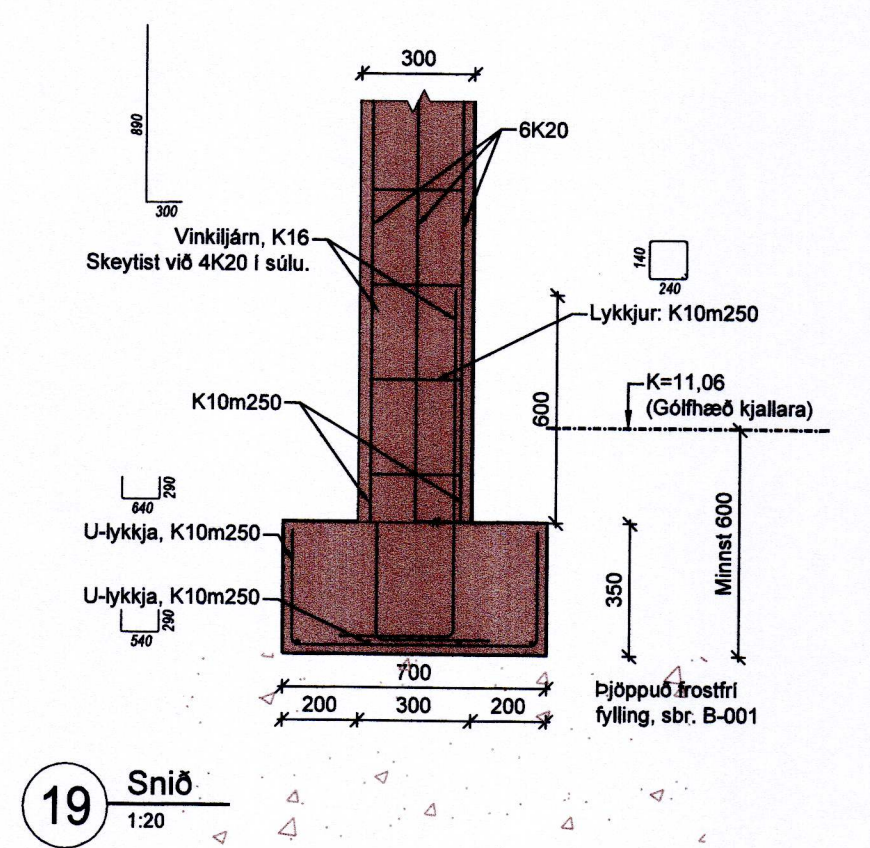
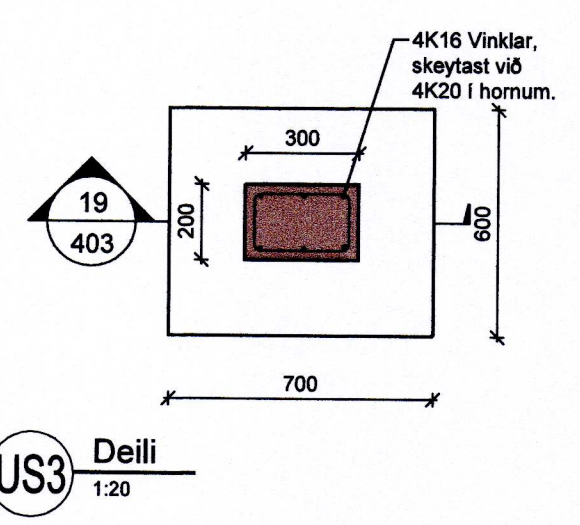
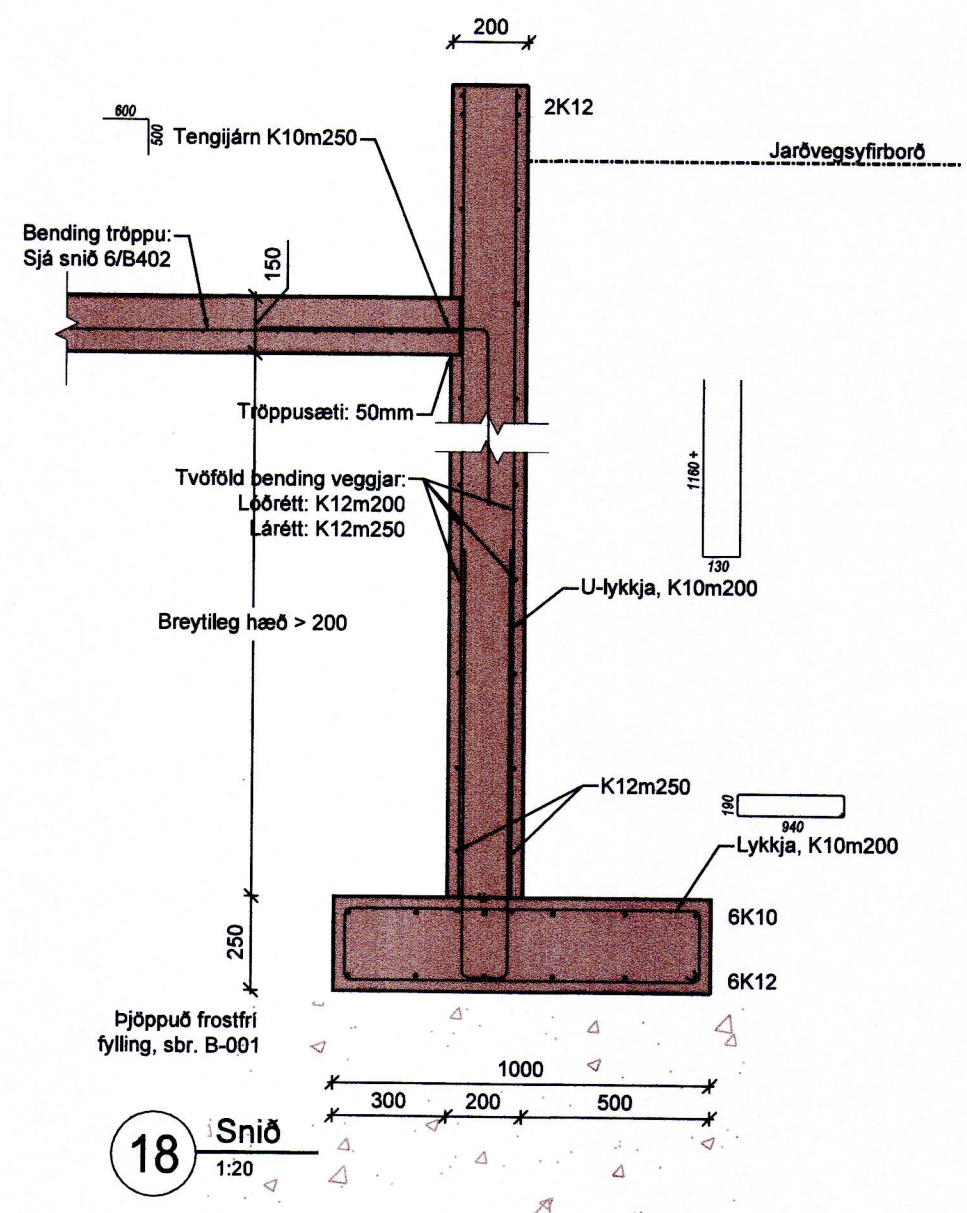
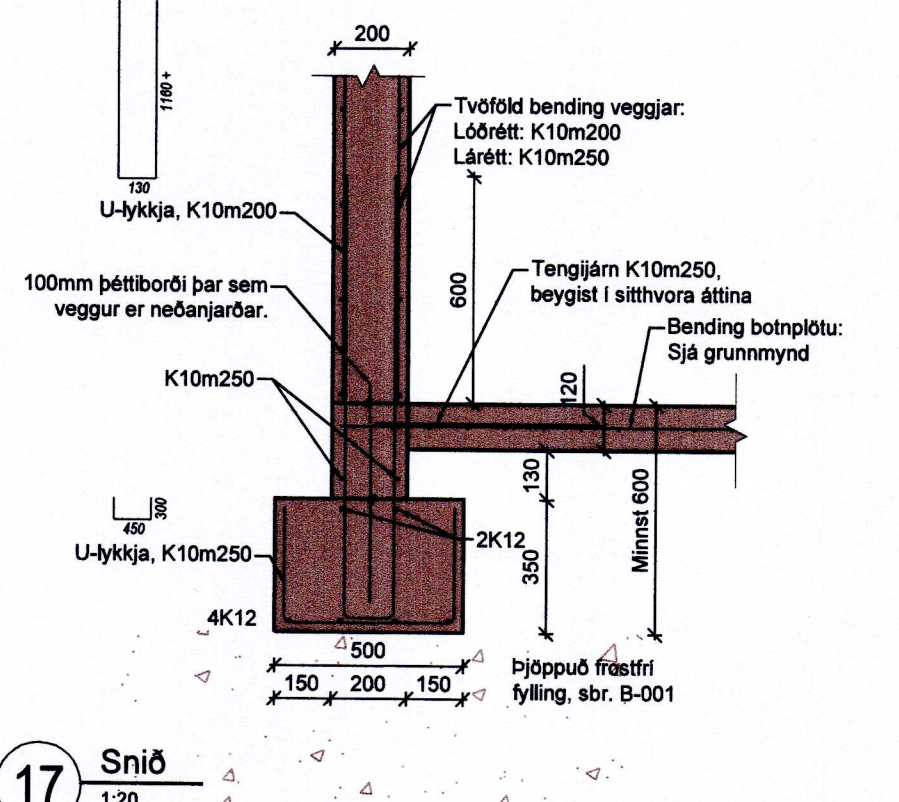
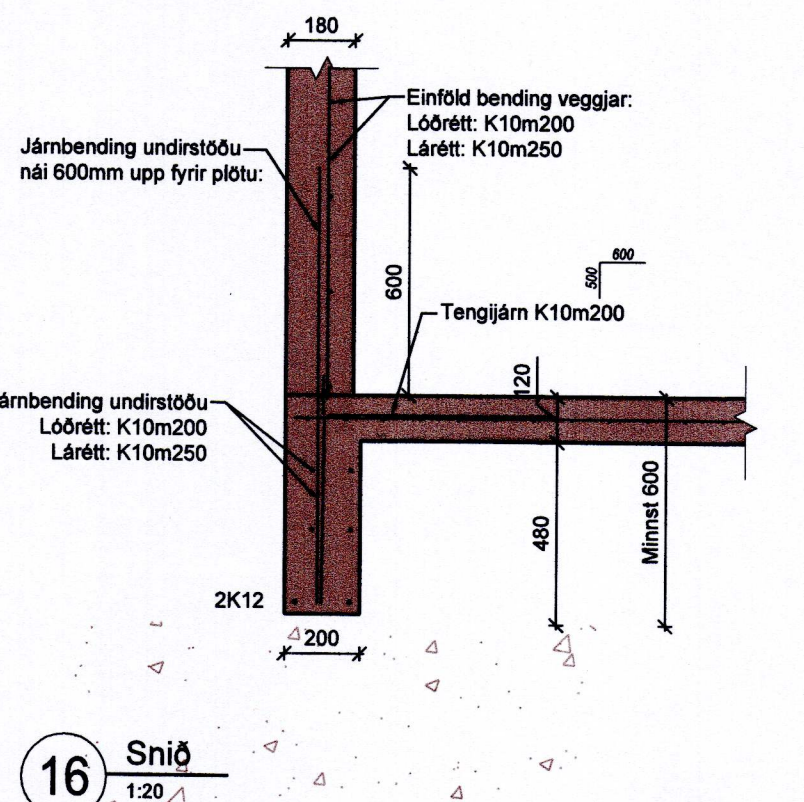
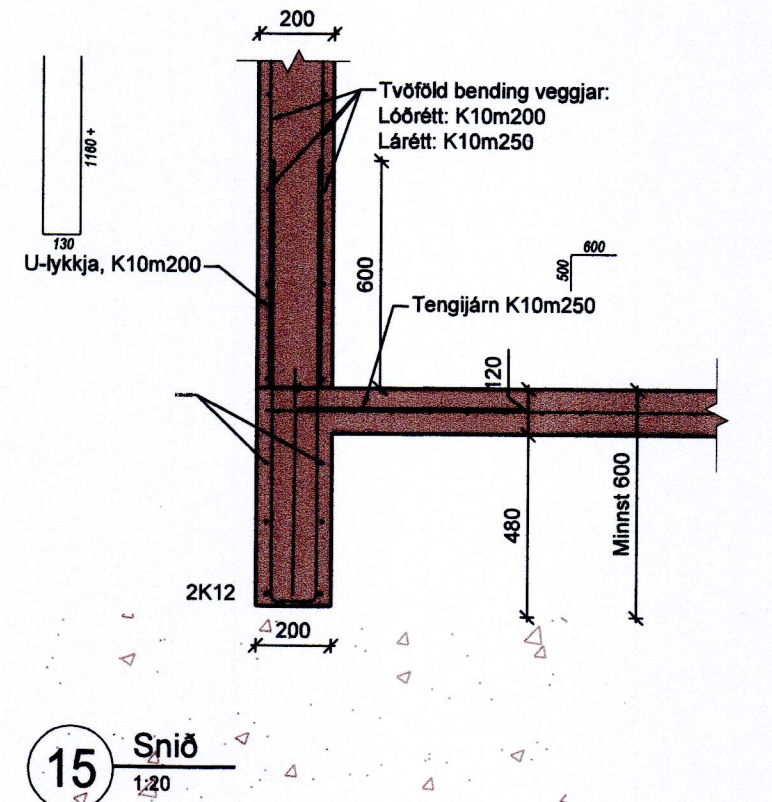
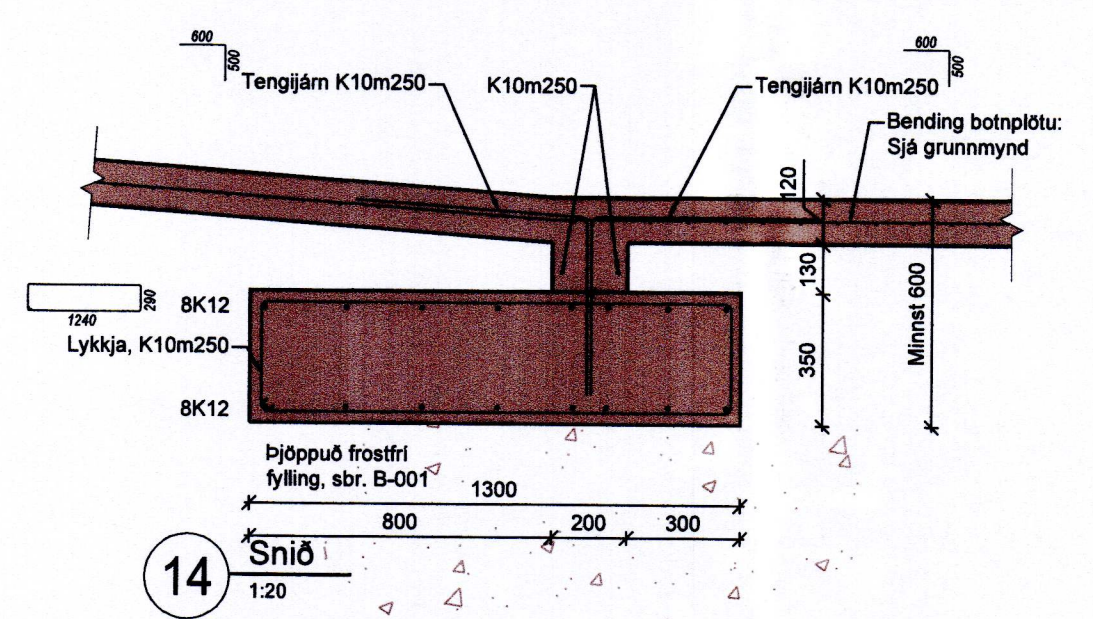
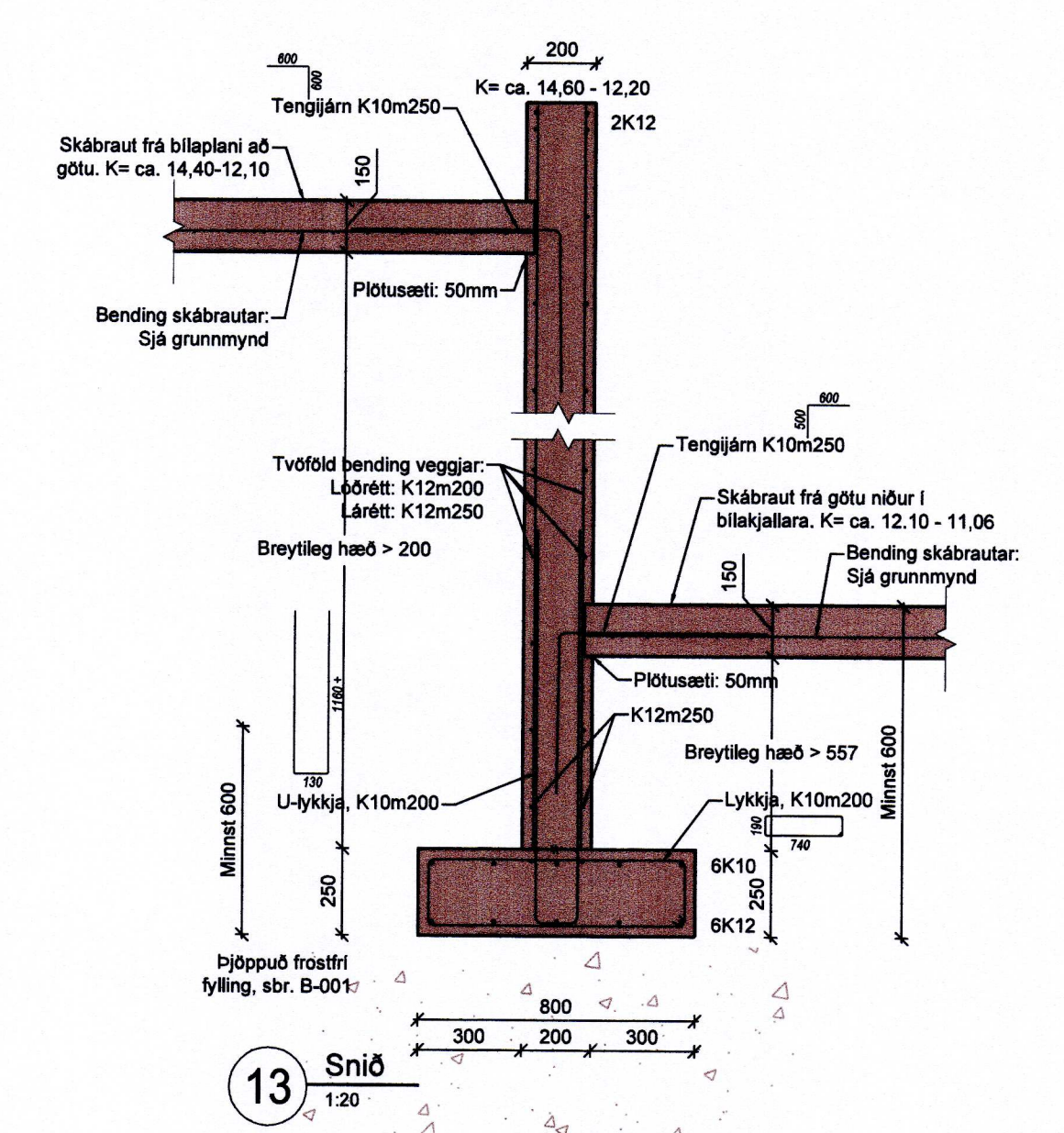
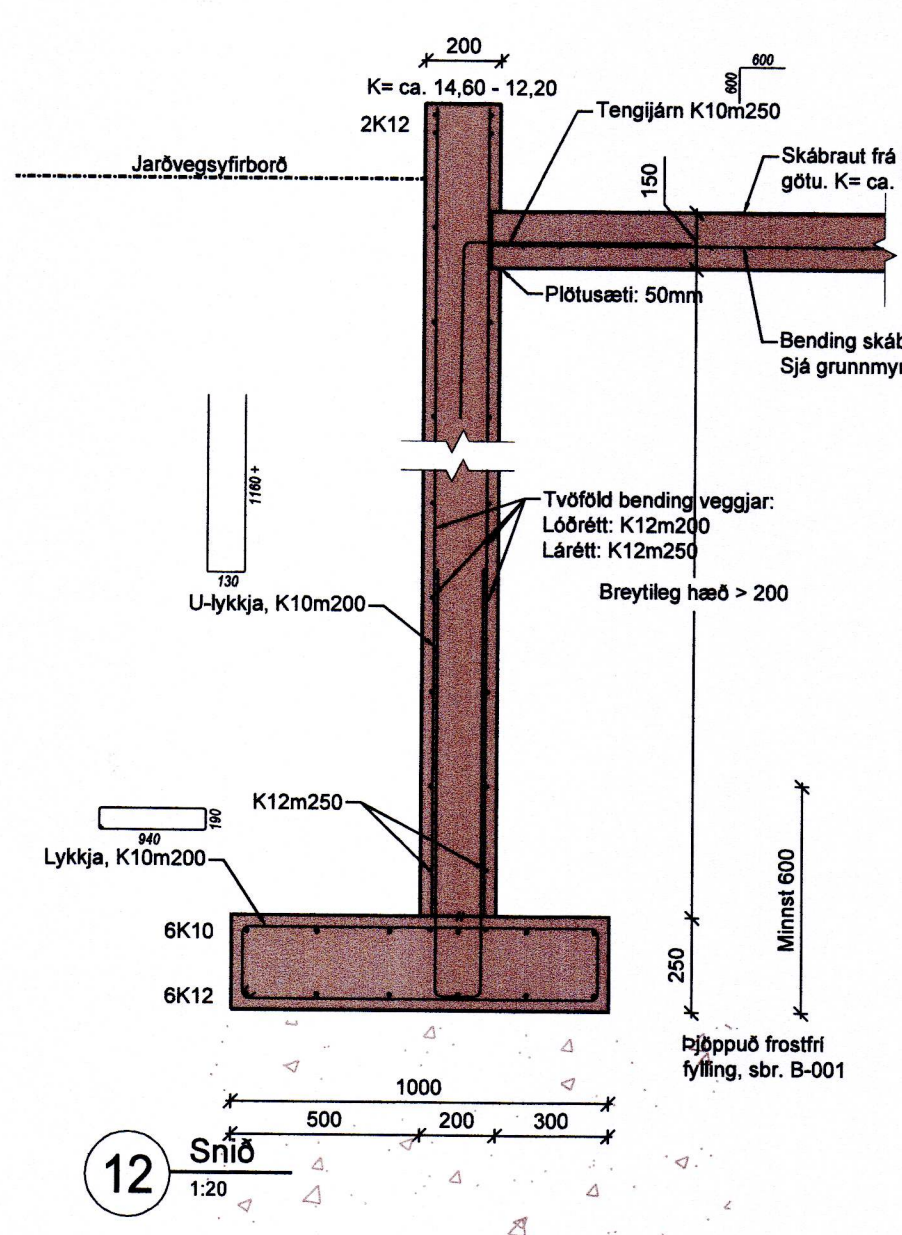
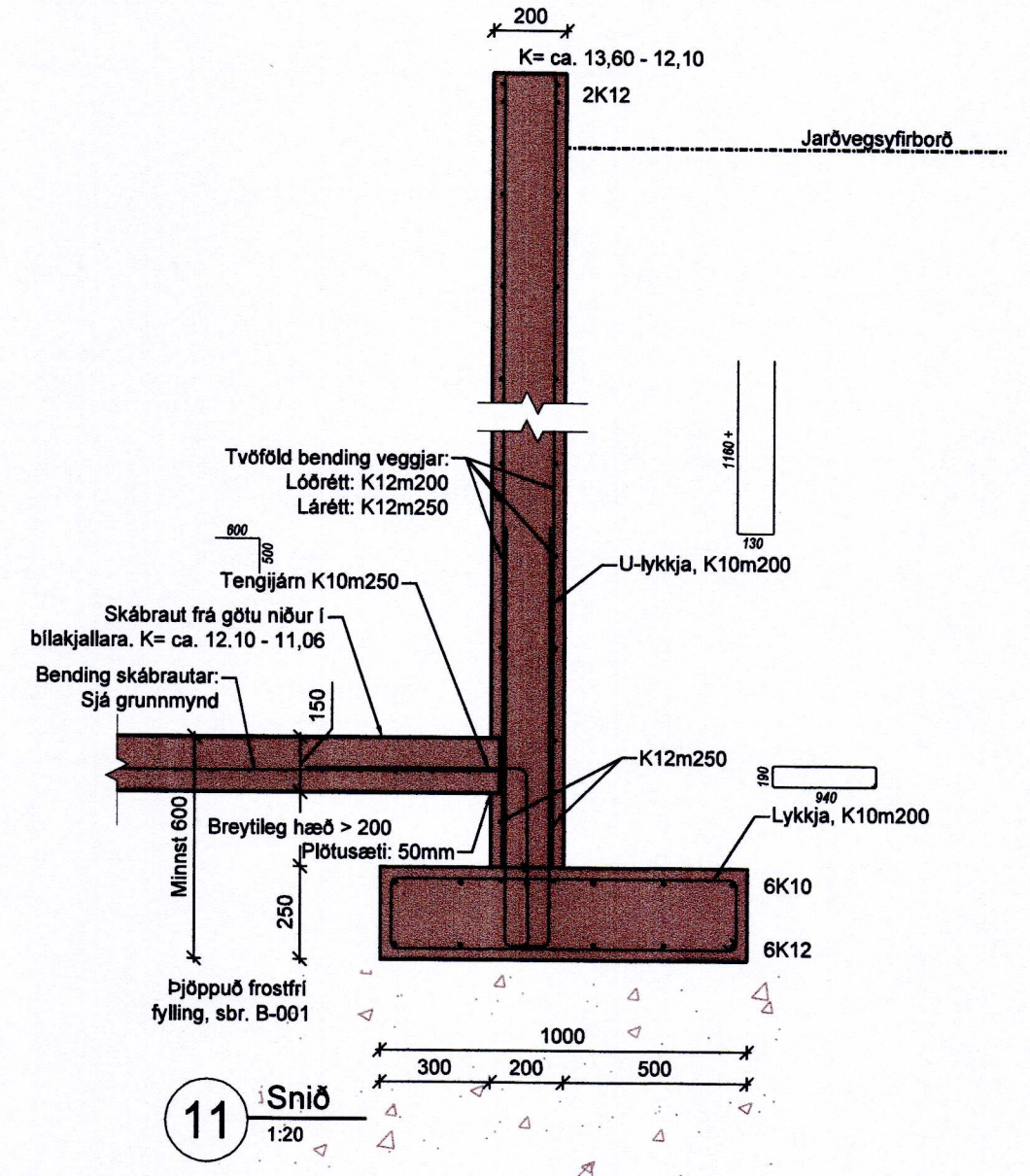
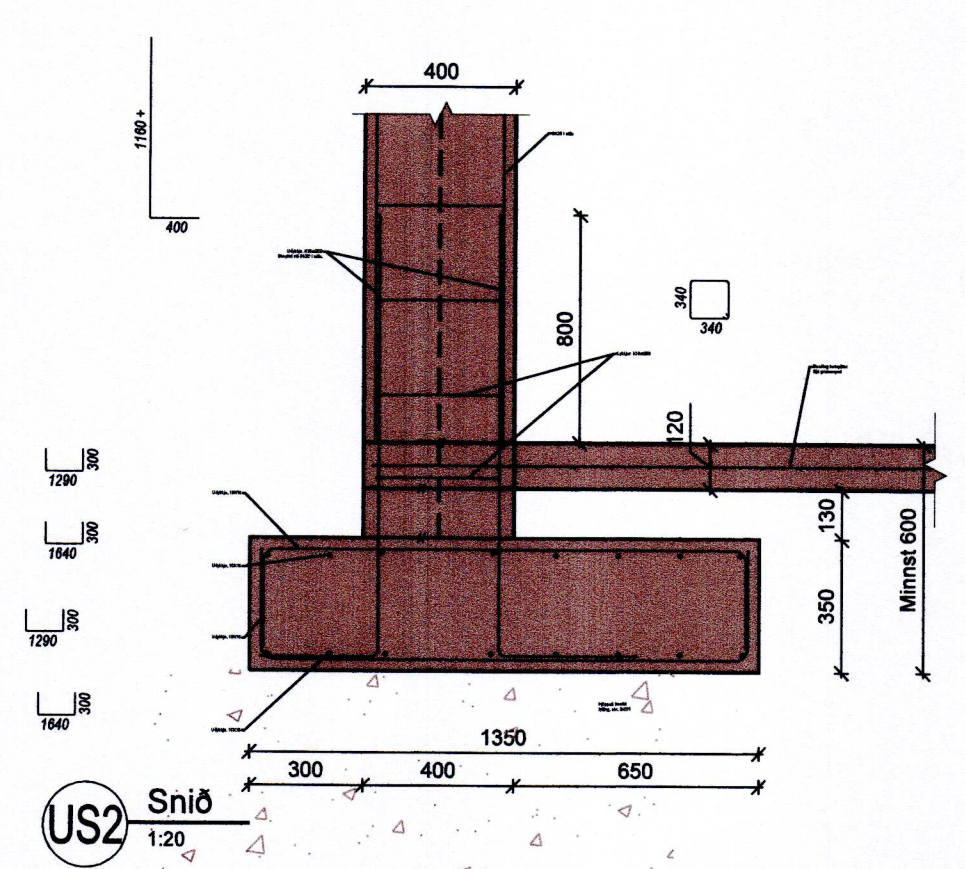
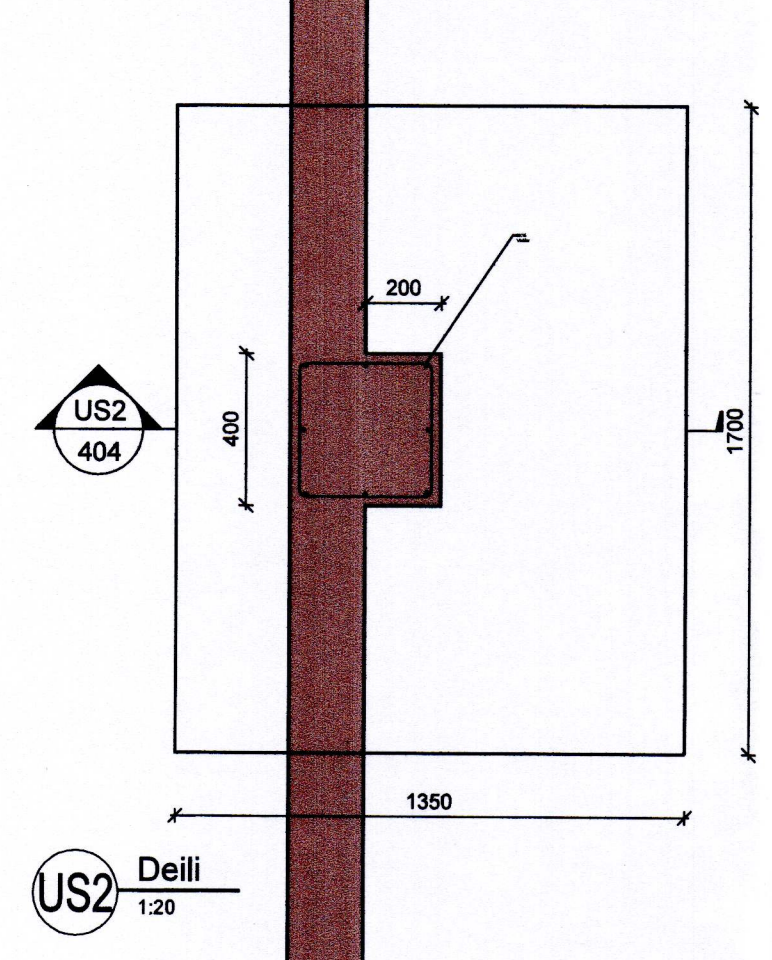
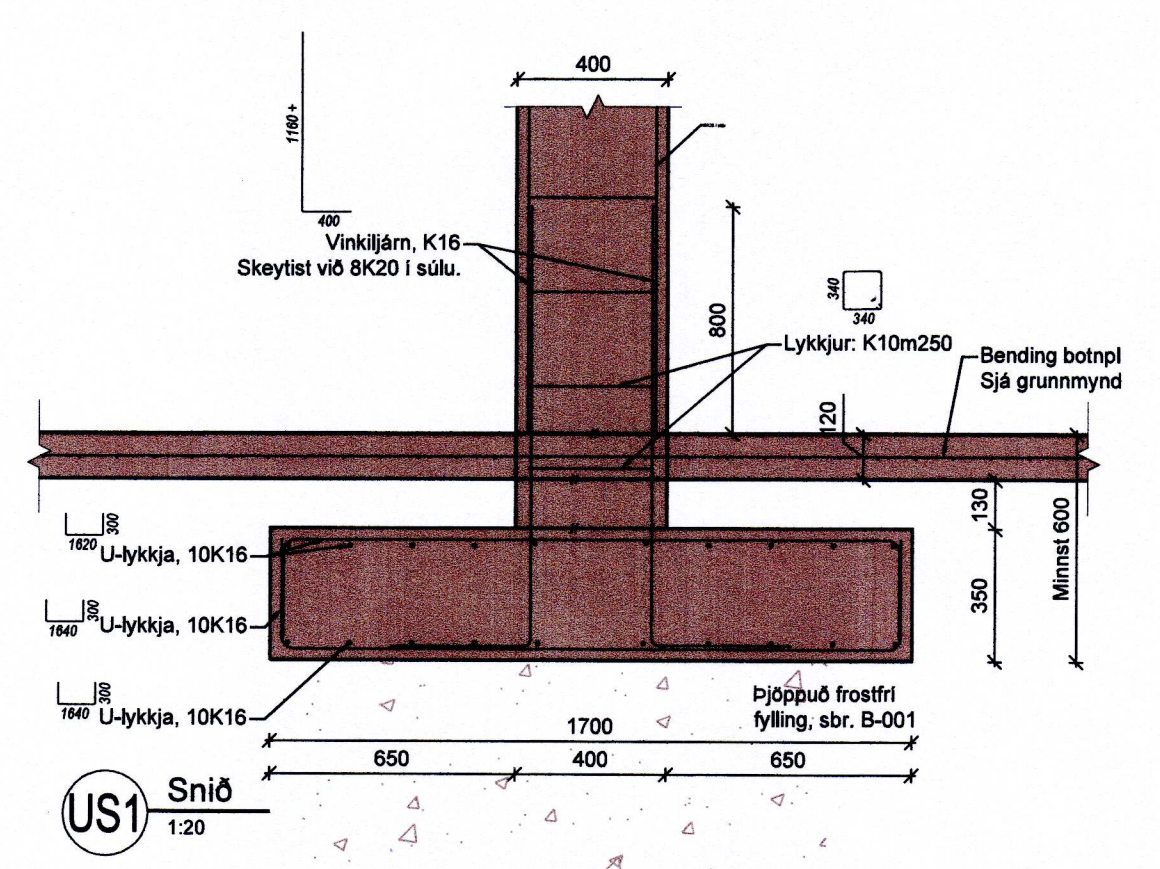
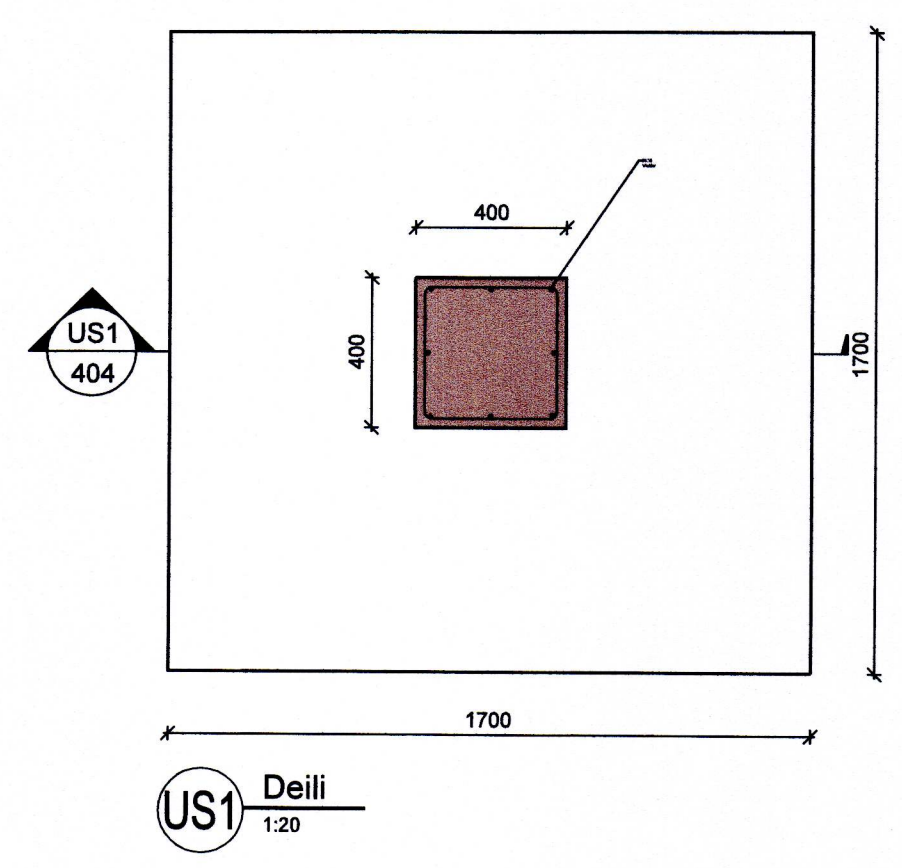

C:\Users\Sami\OneDrive\Public\Dropbox\Public\Verkefni\2020\20-871_Sóhlid 4 B-002_Undirstöður.dwg

Br. Dags. Breyting	Hannað Tekn.
SÓHLÍÐ 4 og 4a Vestmannaeyjum	
BURDARVIRKI: Undirstöður Snið og deili	Hannað/teiknað: ssh Yfirfarið: ssh
Samþykkt: Kt.: 200752-4659	
Mælikvæði: 1:50 (A1)	Dagsetning: 19.04.2021
Verknúmer: 20-871	Teikn.nr.: B-403