

18.04.01

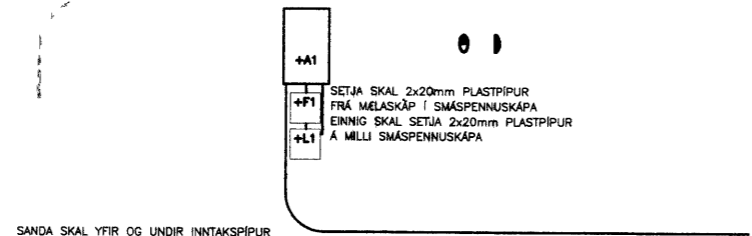

LAMPAR MED UPP LJÓSI



SANDA SKAL YFIR OG UNDIR INNTAKSPIPUR
SETJA SKAL MERKIBORDA ÚRB 50cm OFAN VÍÐ PIPIUR
SETJA SKAL AMK 4 STK 50mm PLASTPIPUR SEM NÁI ÓT AD HEIMREIÐ IBÓÐARHÖSS

SNID A001

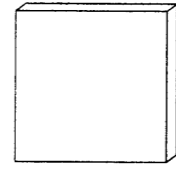

SÍMAKASSI +F1
LOFTNETSKASSI +L1

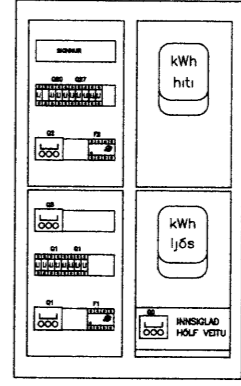

MÆLASKÁPUR +A1

SNID Í STEYPUMÓT

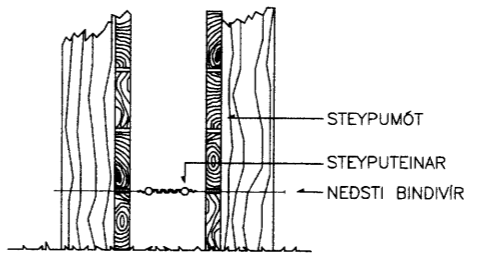

FRÁGANGUR Á SAMTENGIÐUM STEYPUTEINA FYRIR SÖKKULJARÐSKAUT

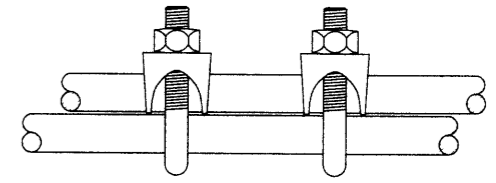

MÆLASKÁPUR +A1

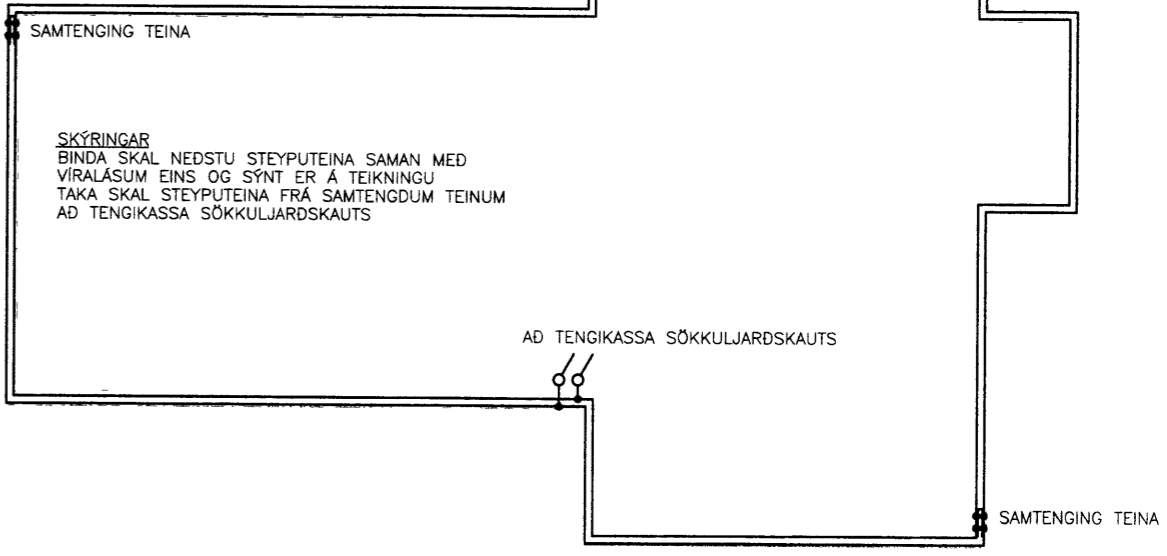
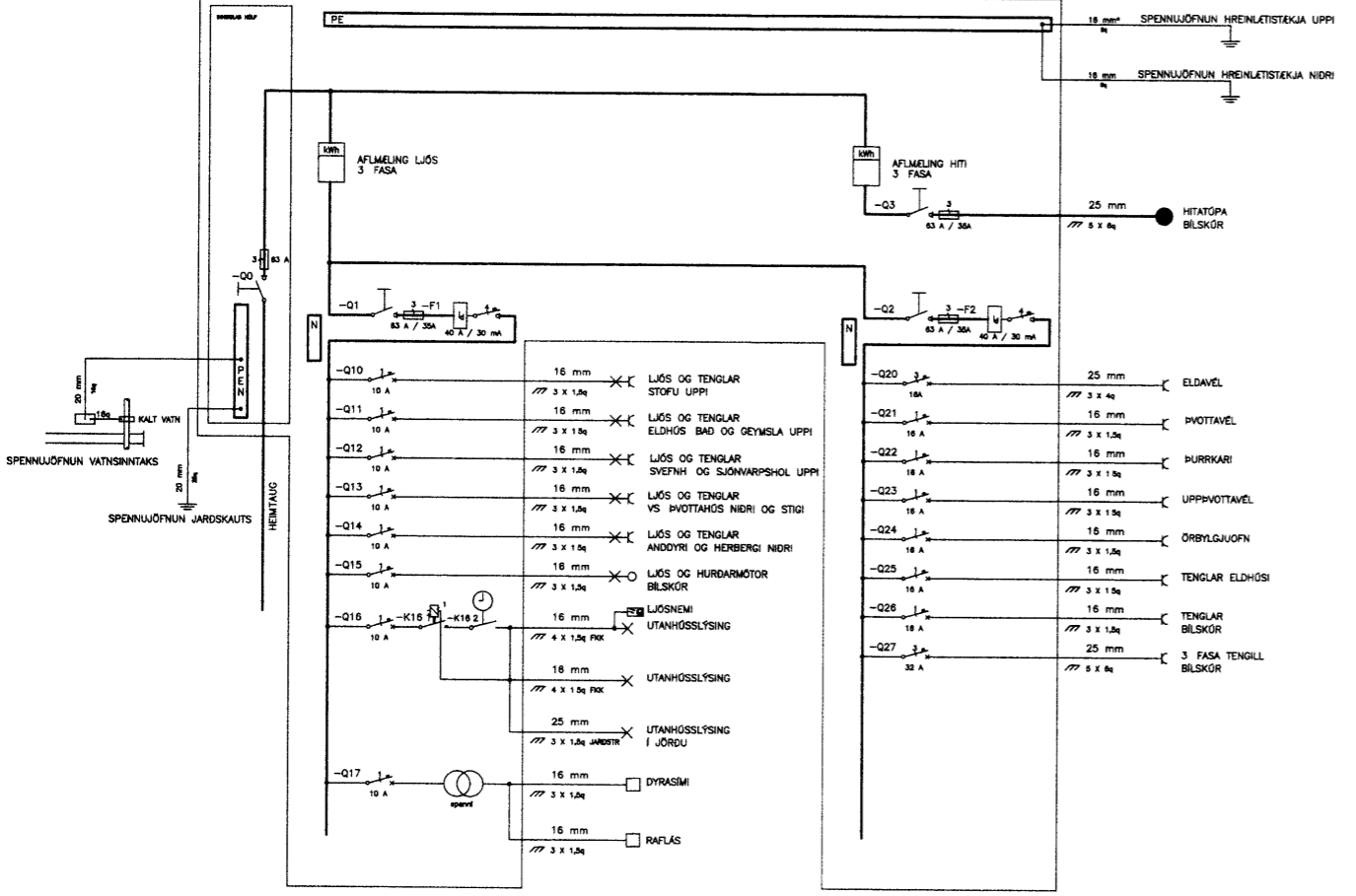

Er þetta teikningu er notað þá er þetta teikningu til notkunar fyrir þetta aðila. Þetta teikningu er notað þá er þetta teikningu til notkunar fyrir þetta aðila.

HANNAÐ	BH
TEIÐN	BH
YFIR	
SAM	
VERKNI	

RAFTEIKNING HF

GVENDARHÚS
LÁGSPENNUKERFI