

1 2 3 4 5 6 7 8 9 10 11 12

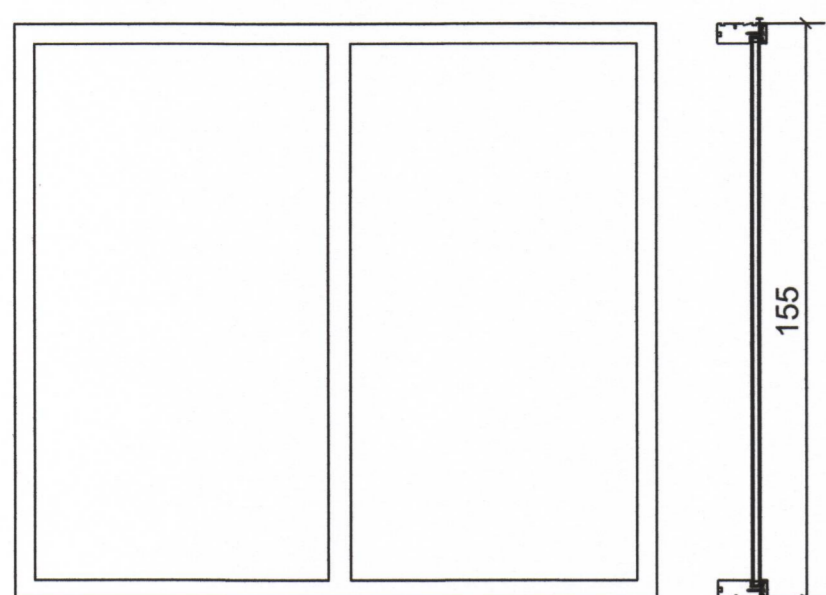

GLUGGI G-1 6 STK. M=1:20

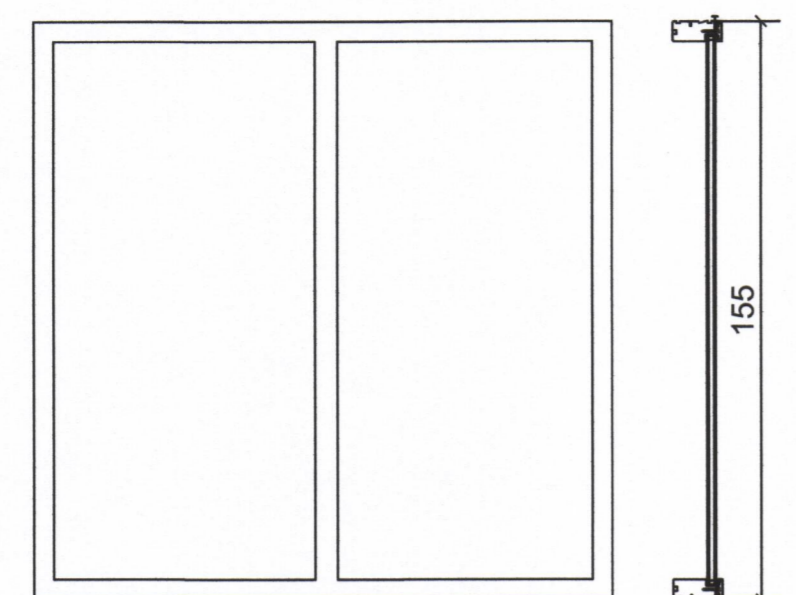
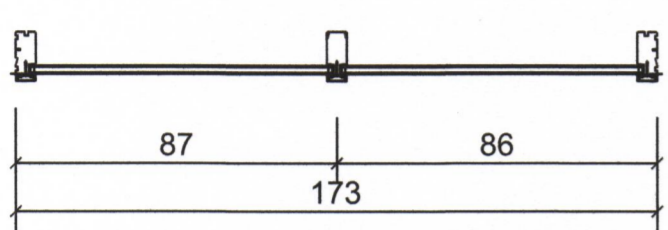

GLUGGI G-2 1 STK. M=1:20

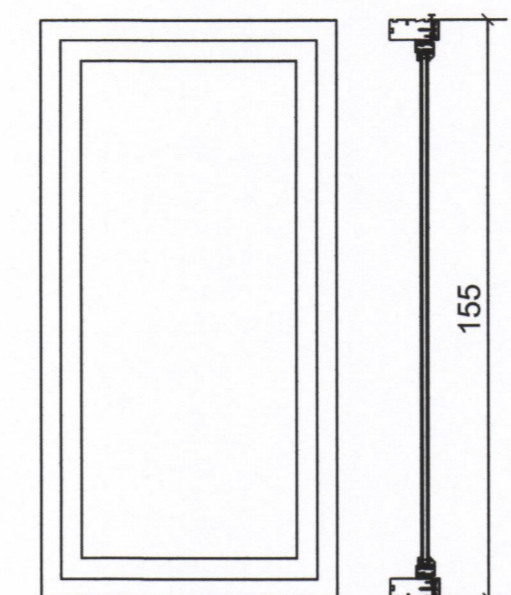
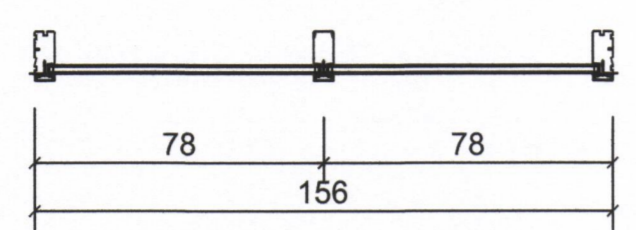

GLUGGI G-3 6 STK. M=1:20

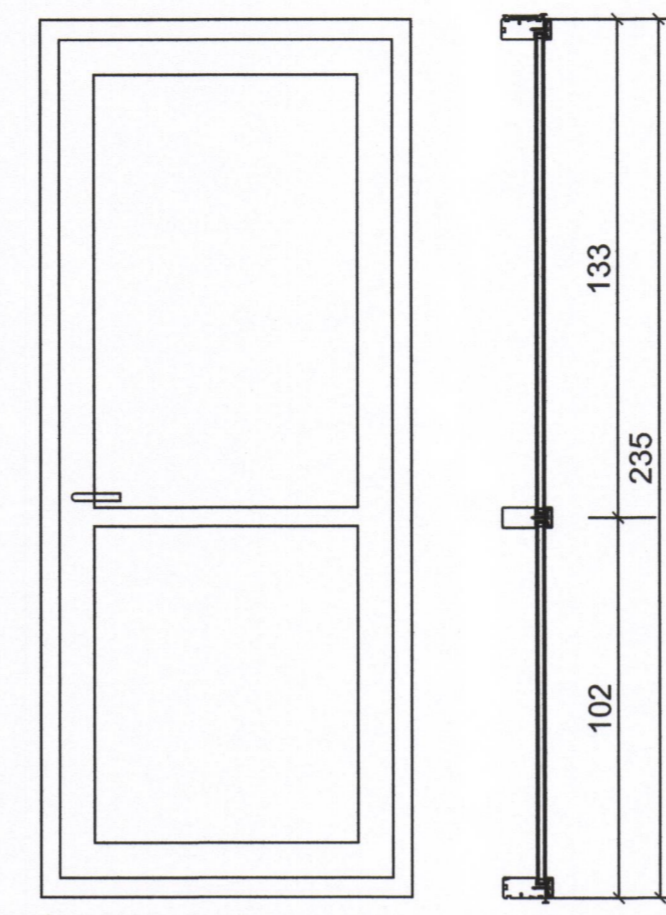
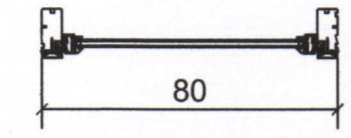

ÚTIHURÐ H-1 1 STK. M=1:20

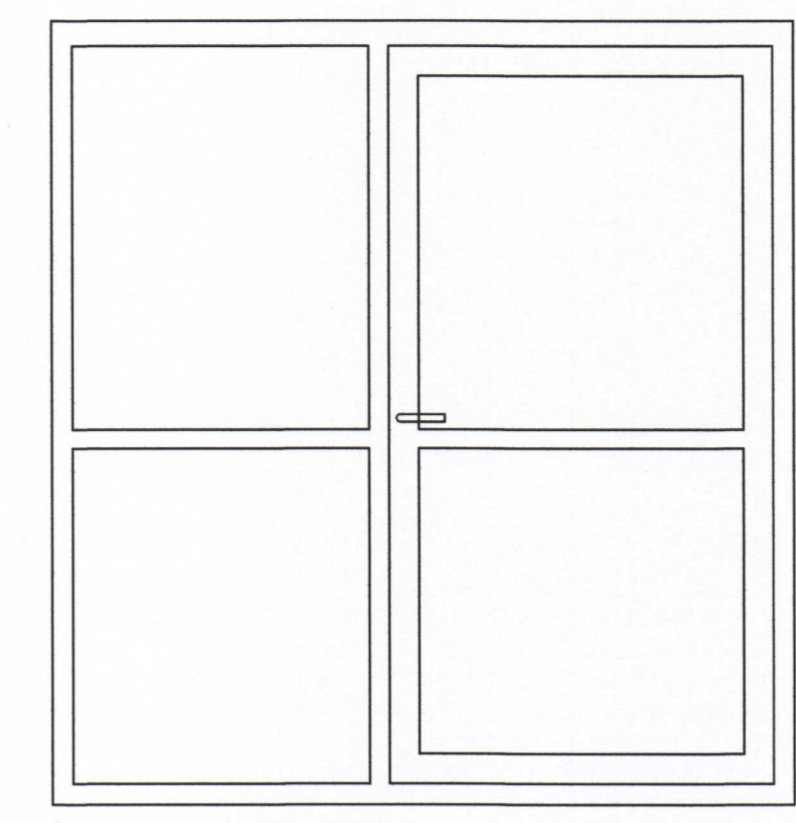
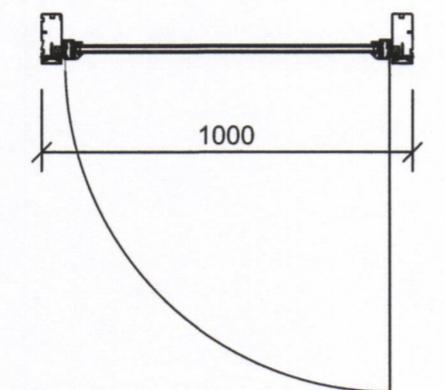

ÚTIHURÐ H-1 1 STK. M=1:20

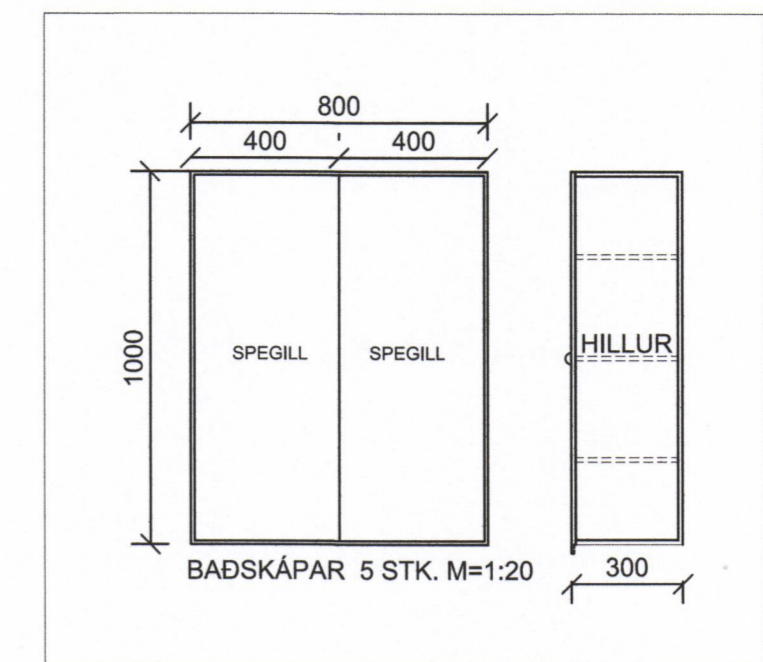
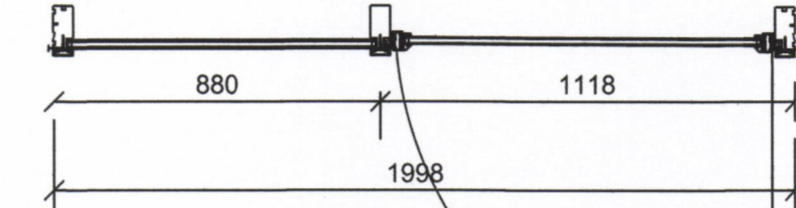

SAMÞYKKT AF BYGGINGARFULLINGA
17. NOV. 2018
BYGGINGARFULLINGA VESTMANNNAEYJUM

UNDIRRITUN SAMRÆMINGARHÖNNUÐAR
Þórgunn Þjórtúnsson
R-270763-5449

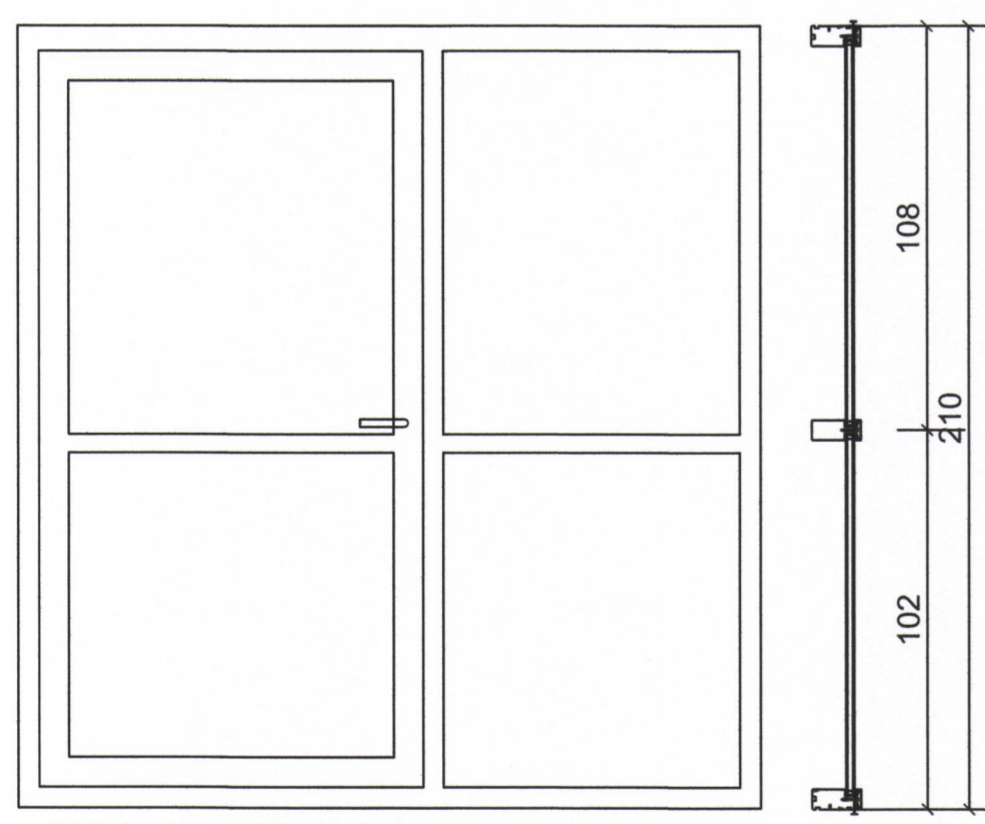
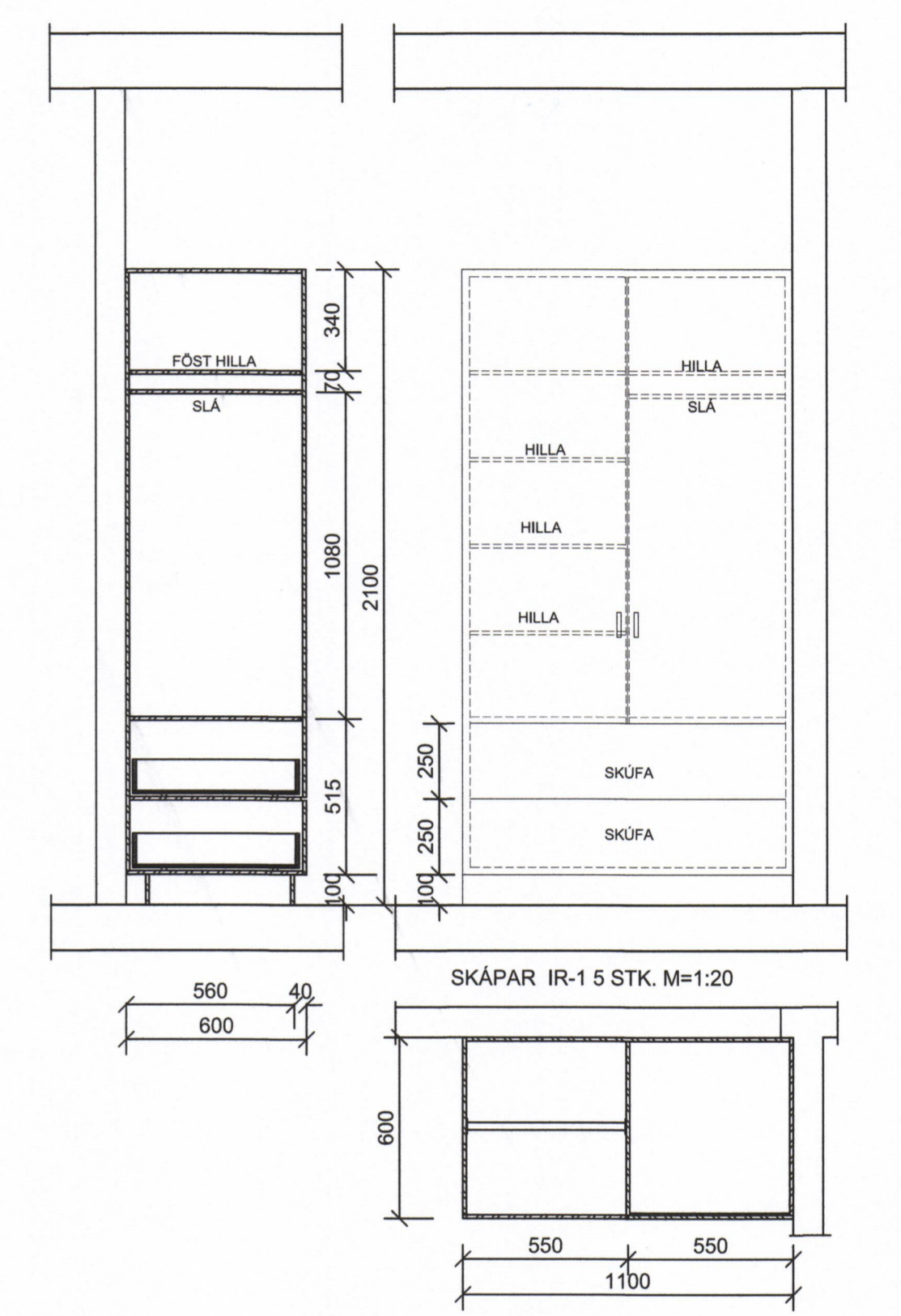

INNIHURÐ H-3 2 STK. M=1:20

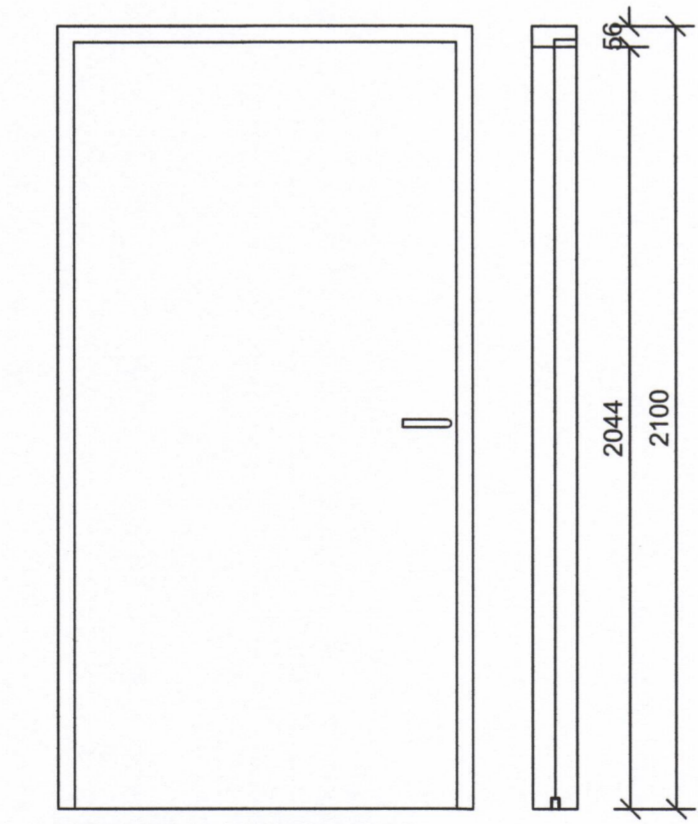
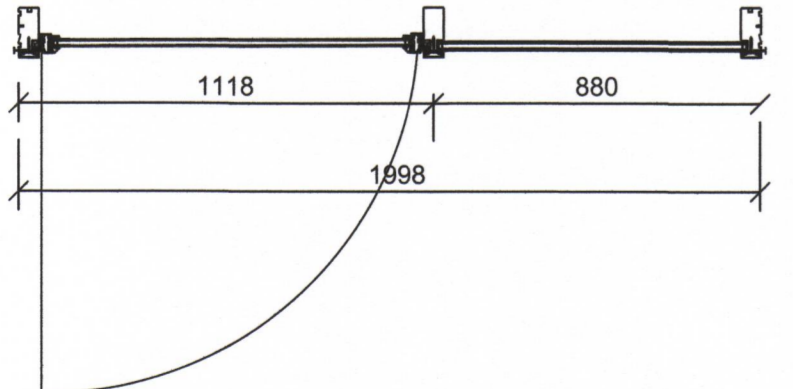

INNIHURÐ H-4 1 STK. M=1:20

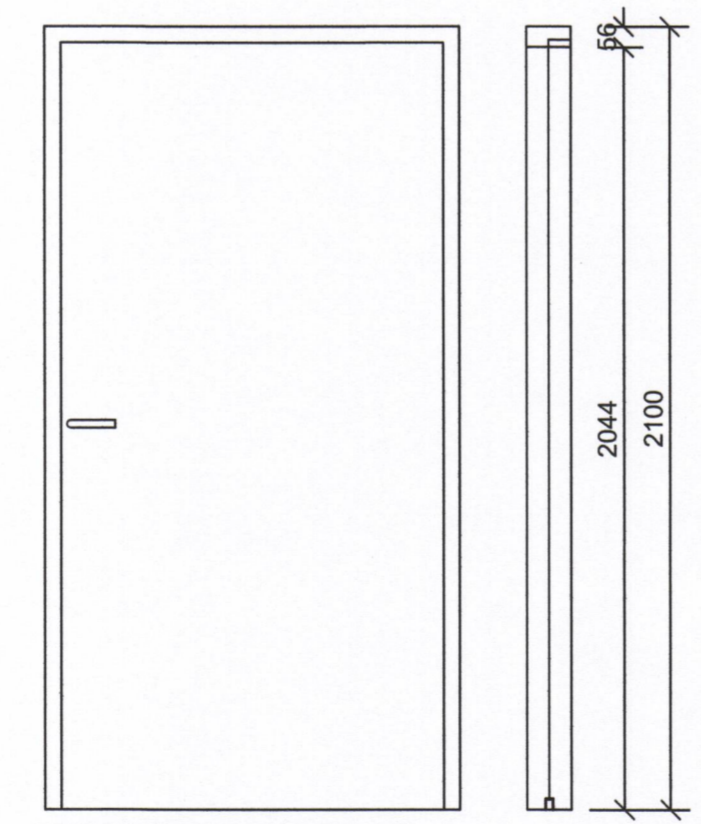
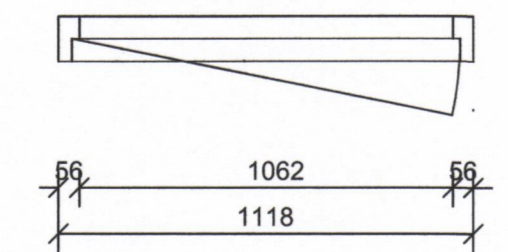

INNIHURÐ H-4 4 STK. M=1:20

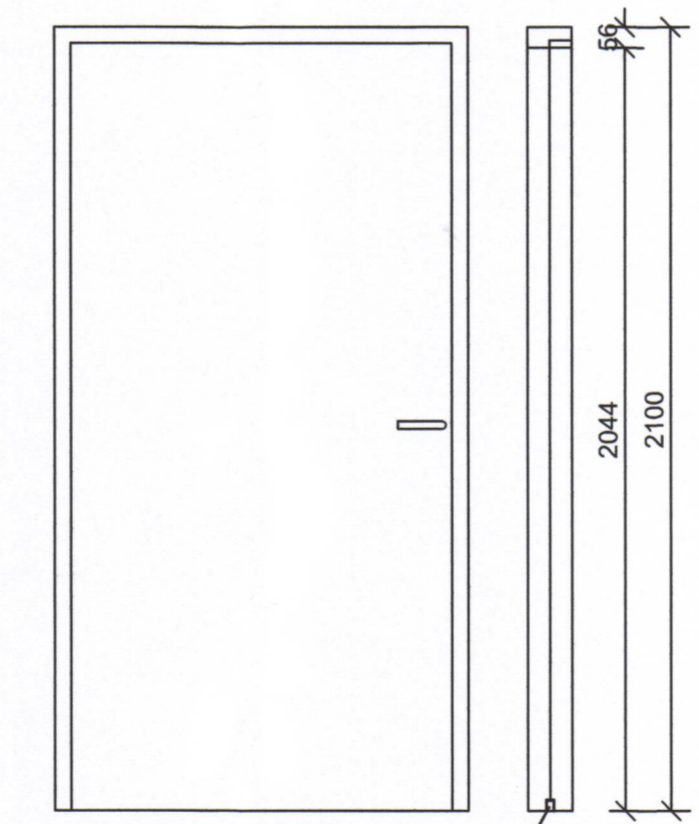
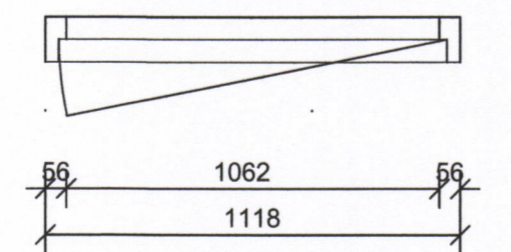

INNIHURÐ H-5 4 STK. M=1:20

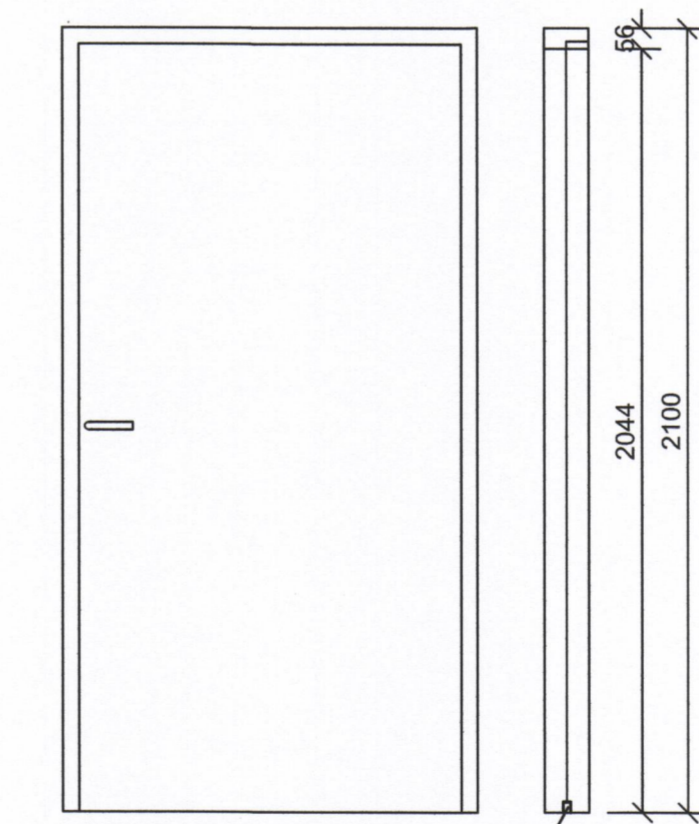
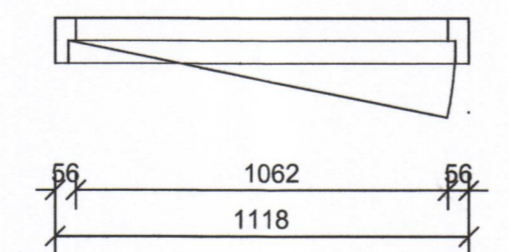

INNIHURÐ H-5 2 STK. M=1:20

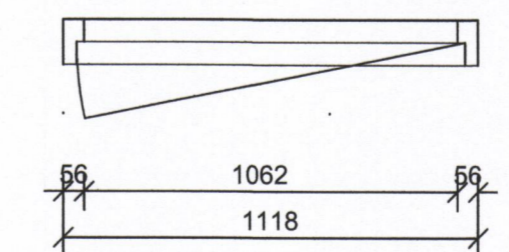

FELLIBRÓSKULDUR

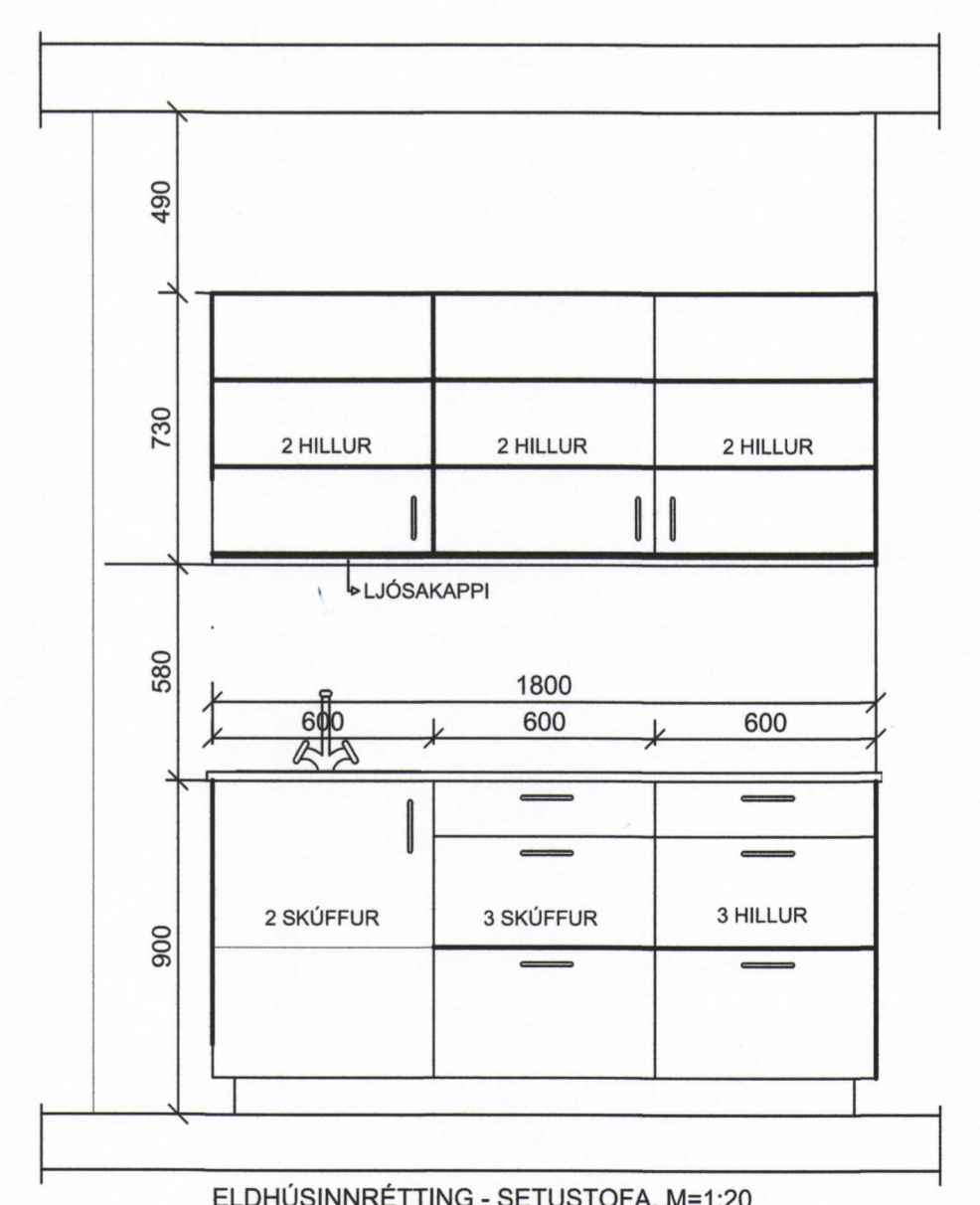

TILVÍSUN	ÚTG. DAGS	SKÝRINGAR	TEIKNANNTYND	ÚTG. DAGS	SKÝRINGAR	TEIKNANNTYND	<p>Kirkjuvegi 23 900 Vestmannaeyjum Sími 481-2711 tpz@teiknistofa.is www.teiknistofa.is</p>	ÚTG. DAGS	HANNAD	MÆLIKVARDI	<p>HRAUNBÚÐIR DVALARHEIMILI VÍÐBYGGING</p> <p>SÉRTEIKNING GLUGGAR, HURÐIR OG SKÁPAR</p>
	01.07.16			01.07.16				<p>YFIRFARID <i>BB</i></p> <p>TEIKNAD RS</p>	<p>1:20 (A1)</p> <p>1:40 (A3)</p>	<p>SAMPYKKT: <i>BB 270763-5449</i></p>	