

FRÁGANGUR ÚTVEGGJAR VIÐ ELÐRA HÚS M=1:10

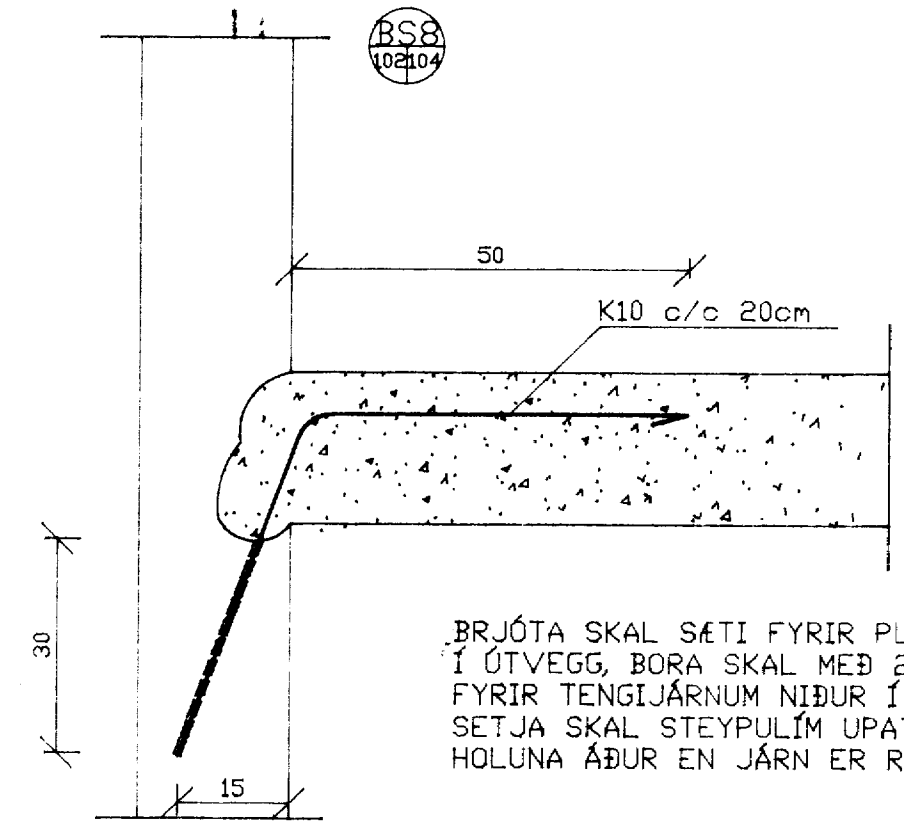

FRÁGANGUR Á PLÖTU VIÐ ELÐRA HÚS M=1:10

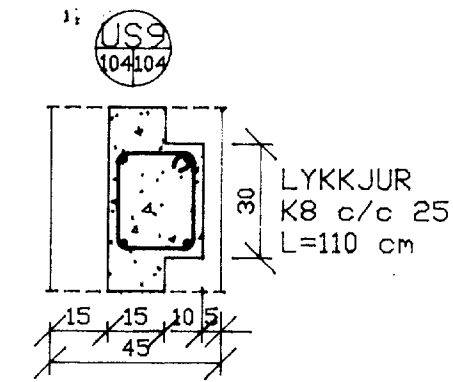
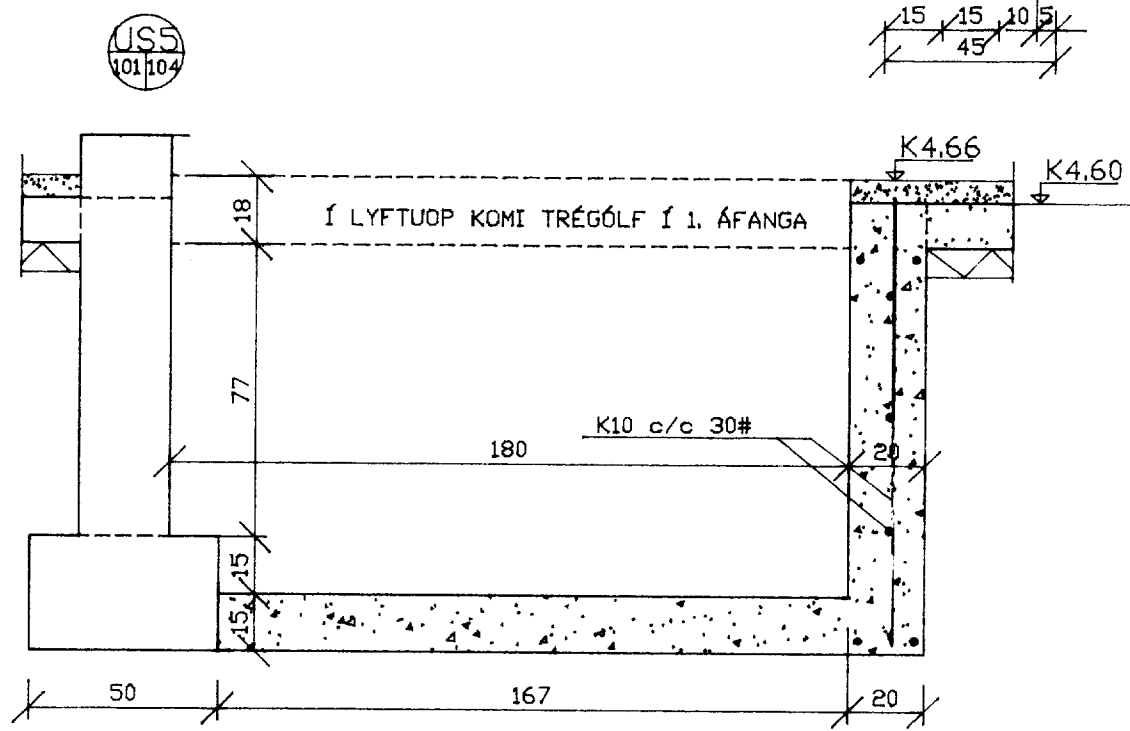
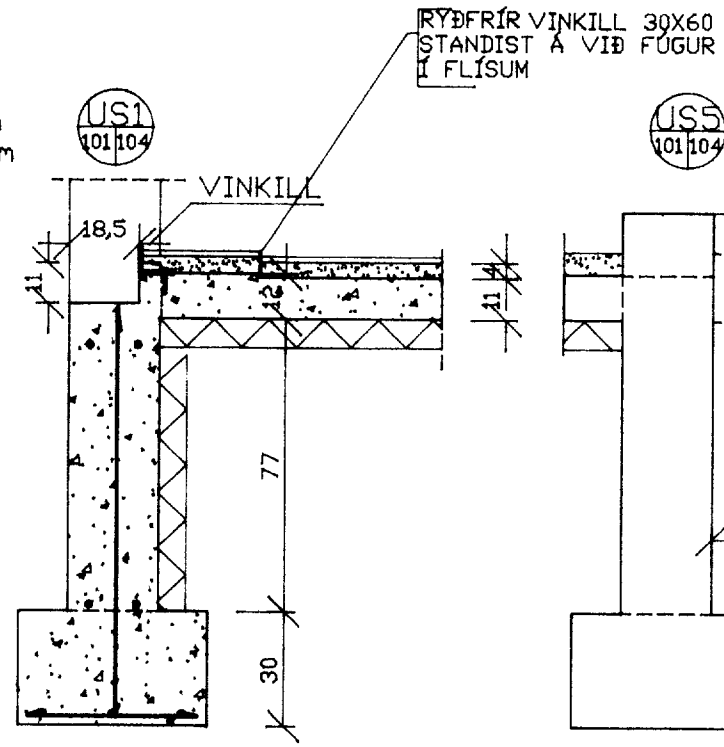
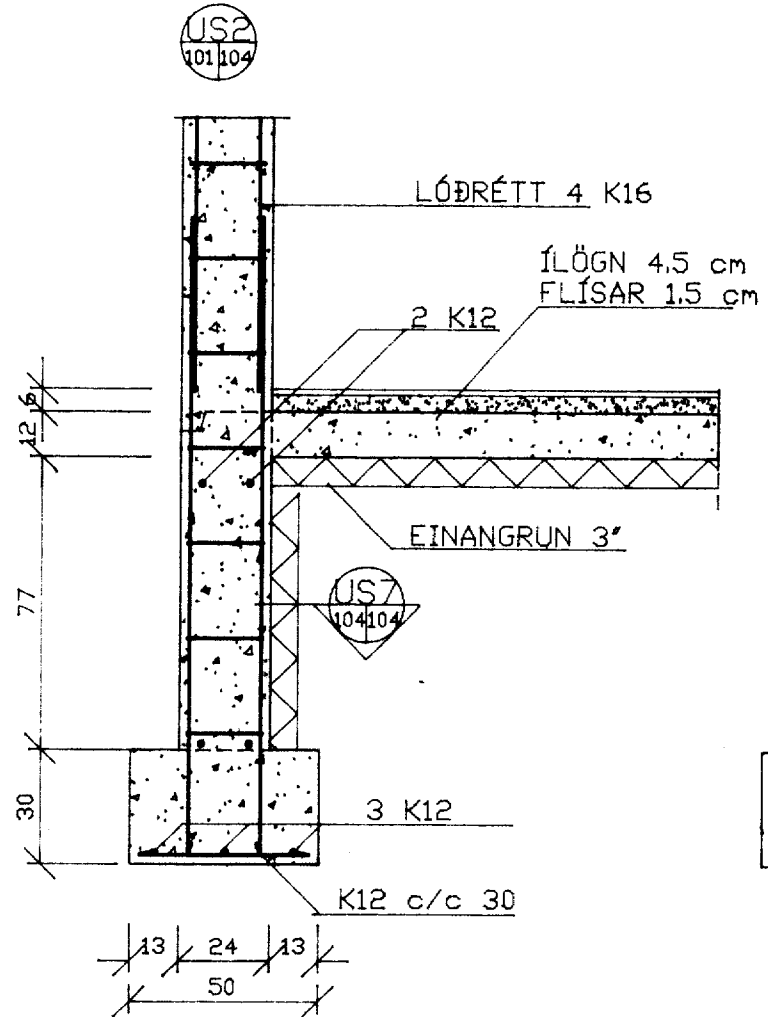
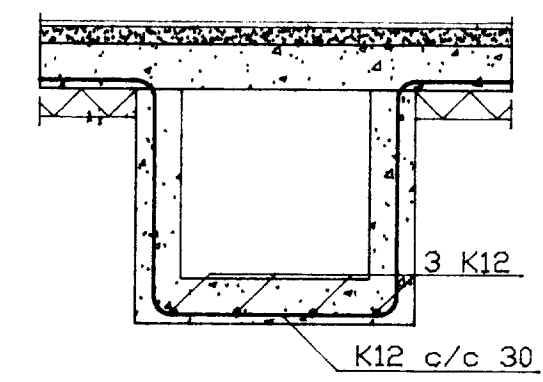
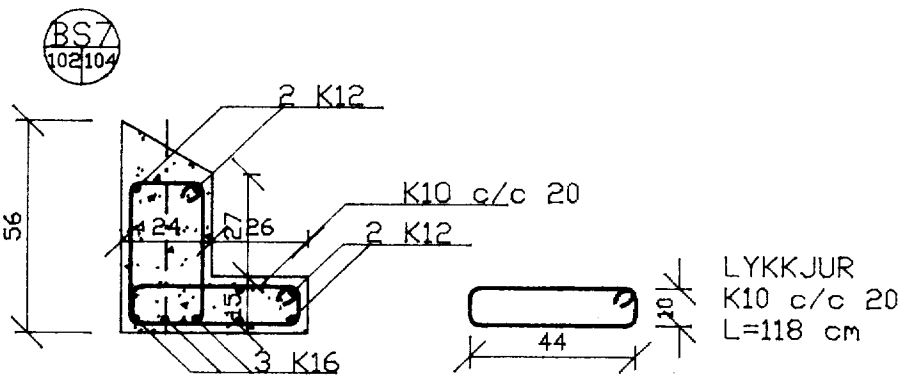
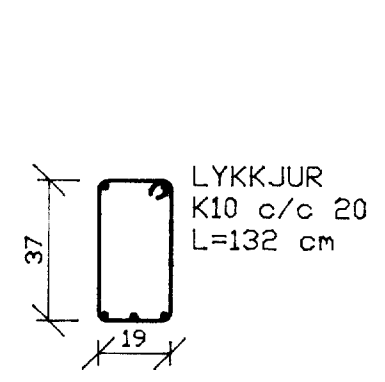
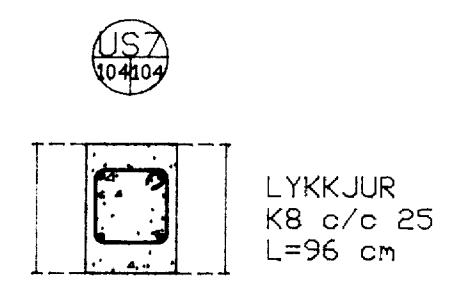

LAGNASTOKKUR UNDIR SALERNI M=1:20

breyting A	breyting C	verkefni	AFGREIÐSLA HERJÓLFS VESTMANNAEYJUM	PÁLL ZÓPHÓNÍASSON TEIKNISTOFA RÁÐGJAFAVEKFRÆÐIÞJÓNUSTA F.R.V. KIRKJUVEGI 23 900 VESTMANNAEYJUM. SÍMI 98-12711, 12239 TELEFAX 98-13076	verk nr. 9327	dags. NÓV, 93
breyting B	breyting D	verkefni	2. ÁFANGI UNDIRSTÖÐUR SÉRTEIKNINGAR			breyting
málkv. 1:20, 1:10	tekn. EA	hannað PZ			tekn. nr. 104	