

30 MAÍ 2000

[Signature]
BYGGINGARFULLTRÚINN Í VESTMÁNNAEYJUM

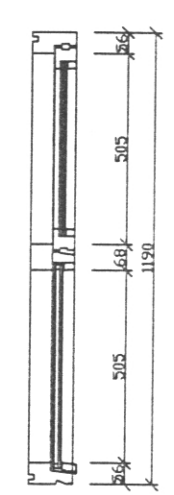
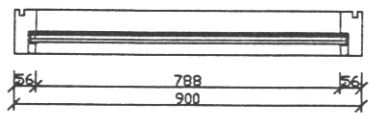
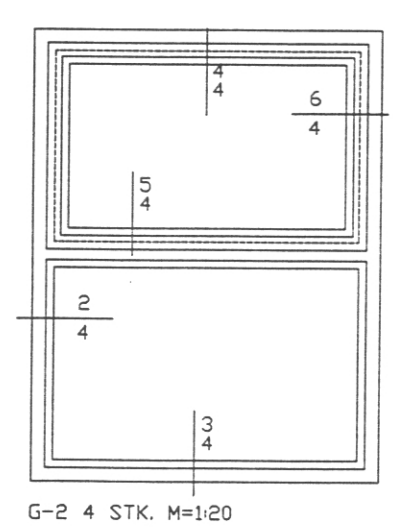
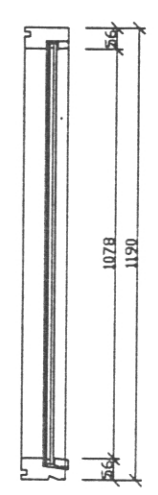
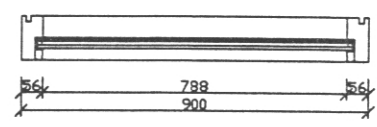
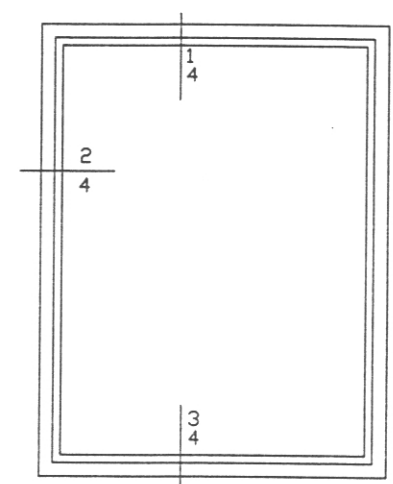
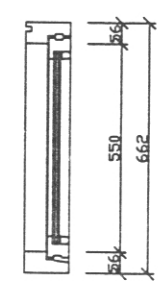
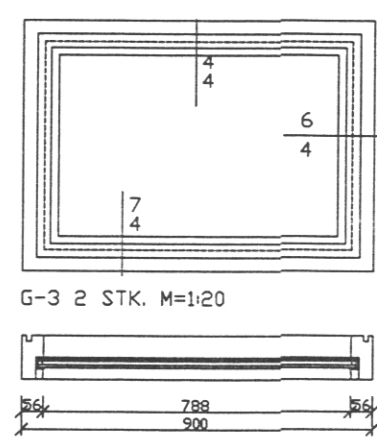
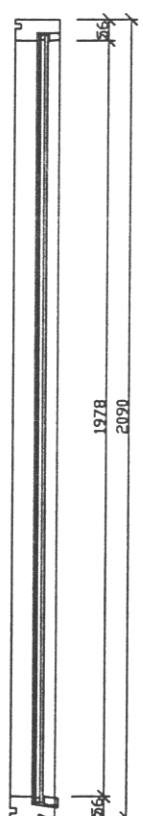
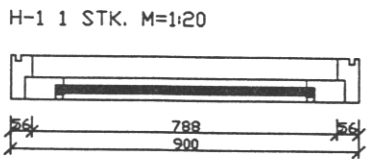
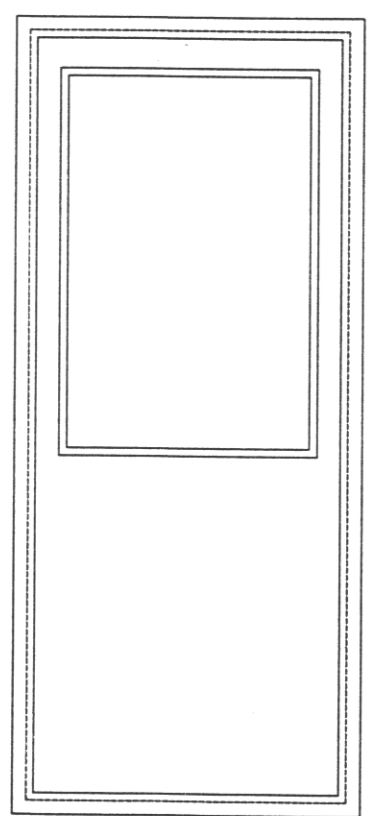
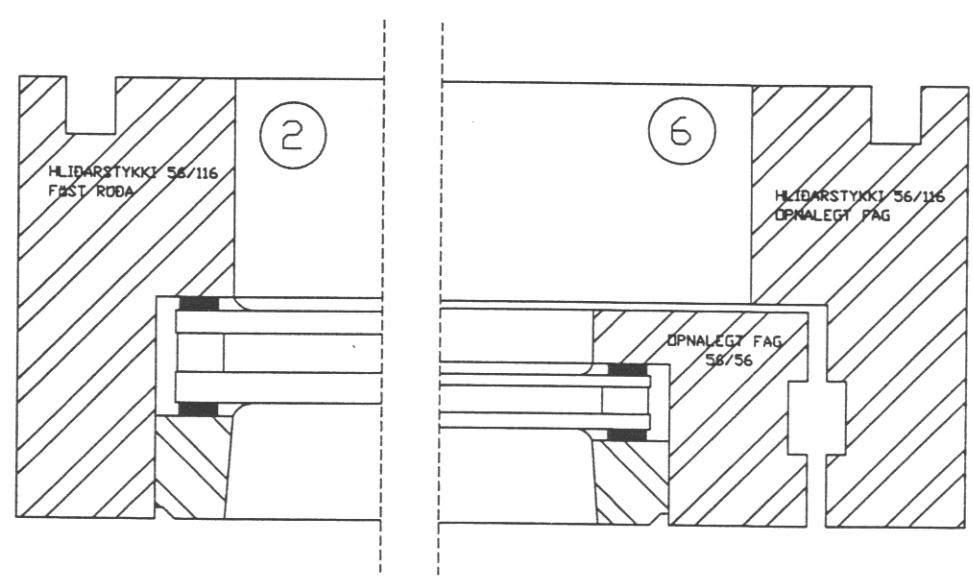
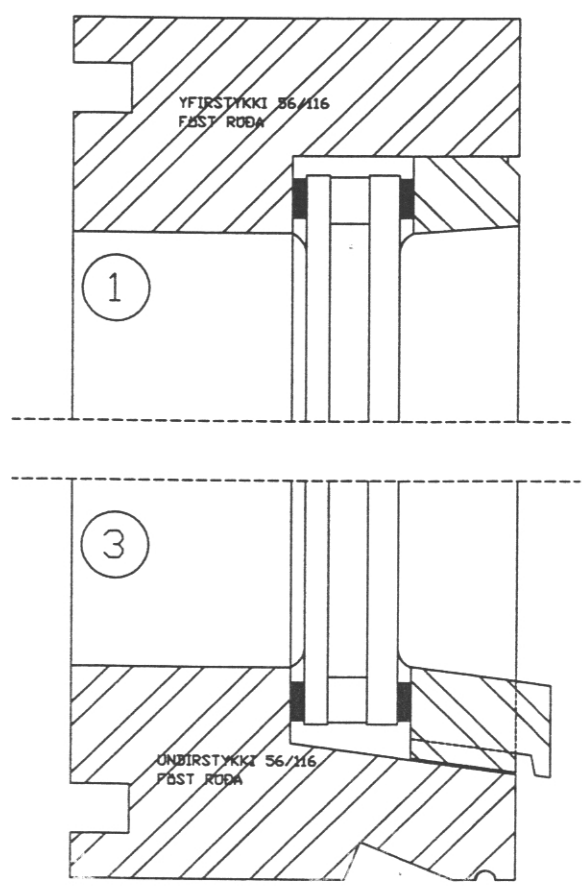
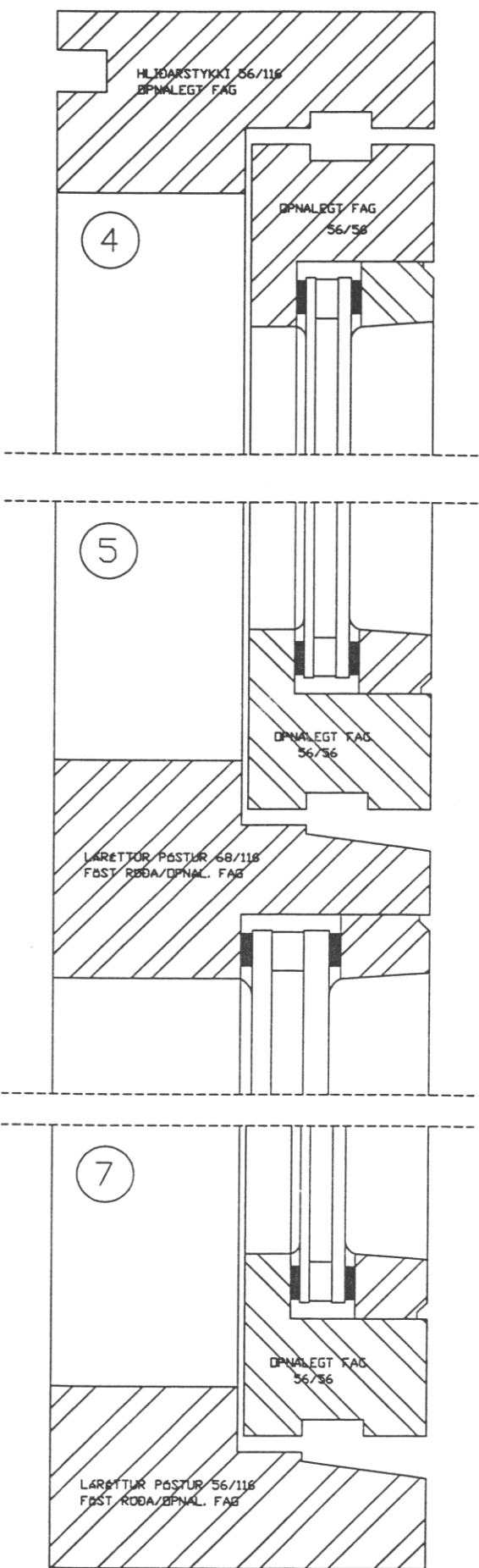

ÖLL MÁL TAKIST Á STAÐNUM ÁÐUR EN SMÍÐI HEFST

breyting A	breyting C	verkefni	ASHARAR 26 VESTMÁNNAEYJUM	TEIKNISTOFA PZ EHF	verk nr.	9841	dags.	NOV 99
breyting B	breyting D	verkefni	OLUGAR	REG. AF VÆRÐINGARSTJÓRN				
meilkv. 12. 12. telkn. FA	hannóð SP		ÖLÍY OG SERTSEIÐINGAR	KIRKJUVEGI 23 900 VESTMÁNNAEYJUM	telkn. nr.	4		
				SÍMI 481-2711, -2239 TELEFAX 481-3076				